

ITRON BELL



Smart Video Doorbell with AI

User Instructions

Packing list

1. Doorbell *1
2. Indoor Chime *1
3. Mounting Brackets (Optional) *2
4. USB Power Cord *2
5. Screw Pack *1
6. Removal Pin*1
7. Doorbell Installation Wire (optional)*2
8. Wiring Cap (optional)*1
9. User Instructions *1



Product Appearance

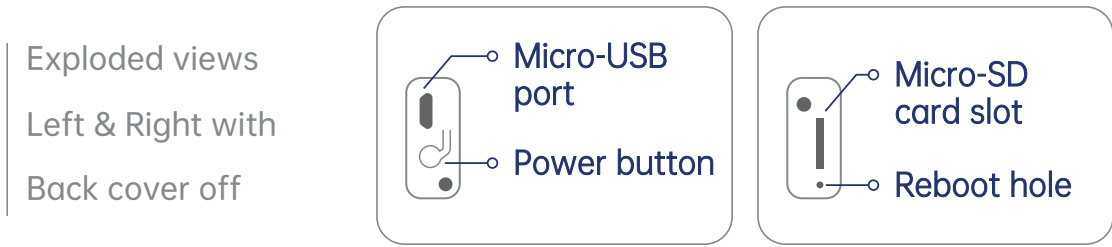
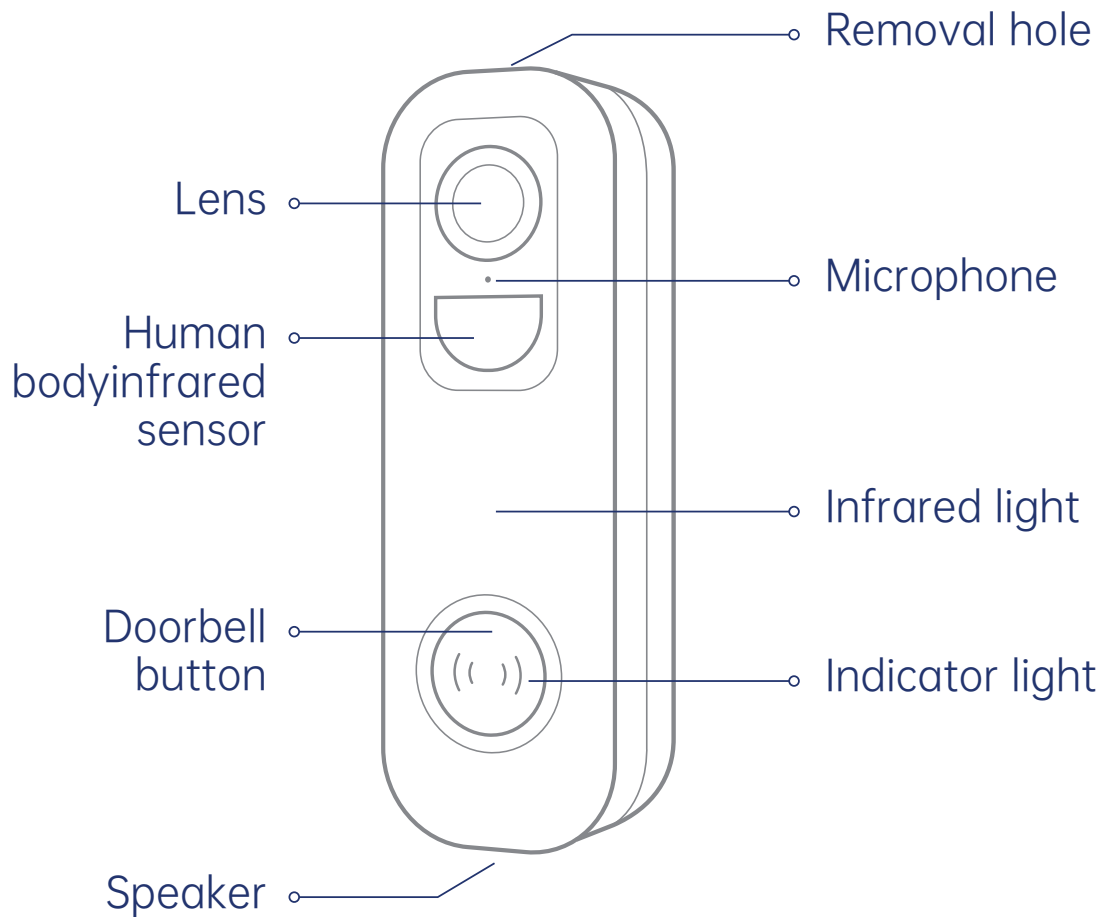

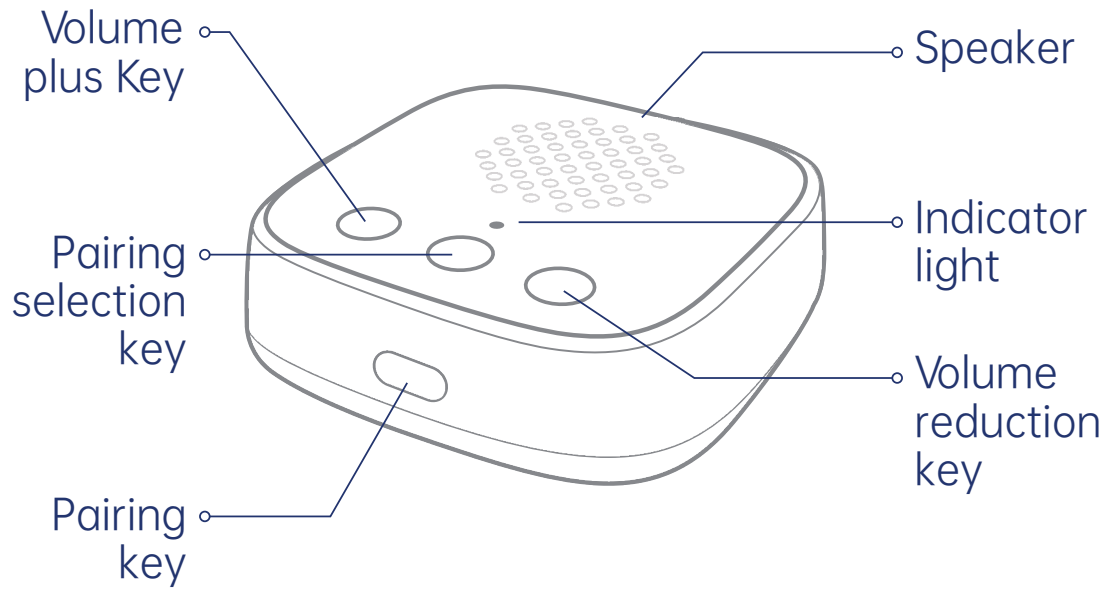

IndoorChime

Getting Started

- The smart iTronBELL supports both wireless battery power supply and wired power supply.

Downloading and installing the App

The iTronBELL can be connected to and operated through smart phones running on Android and iOS platforms. For best experience, please scan the QR code below, download and install the App and follow the prompts to complete user registration.



Adding the iTronBELL

Login to the App and follow the prompts to connect the Wi-Fi and add the doorbell (please keep the doorbell close to the router when it is configured).

Future Supported Function

Alexa and Google Home

Auxiliary installation tools

Phillips head screwdriver *1

Electric drill 1/4" *1 (drill bit 6.35 mm)

How the iTronBELL works

The unpacked doorbell comes in two parts: a doorbell to be affixed to the porch, powered by the built-in battery, and an indoor door chime unit placed in your home powered by USB power socket (Not Included), iTronBell charged by USB, connected to an indoor USB power socket. (Not Included)

The doorbell supports connecting some of mechanical "Ding Dong" chimes.

How to remove the iTronBELL

When you need to dismantle the iTronBELL from the bracket, please use the removal pin to press and insert the removal hole at the top of the iTronBELL, and then take out the doorbell from the back to the front. The version with electronic tamper will trigger a 10s tamper alarm when it is removed, and you can turn it off to cancel the alarm via the App or by long pressing the power button.

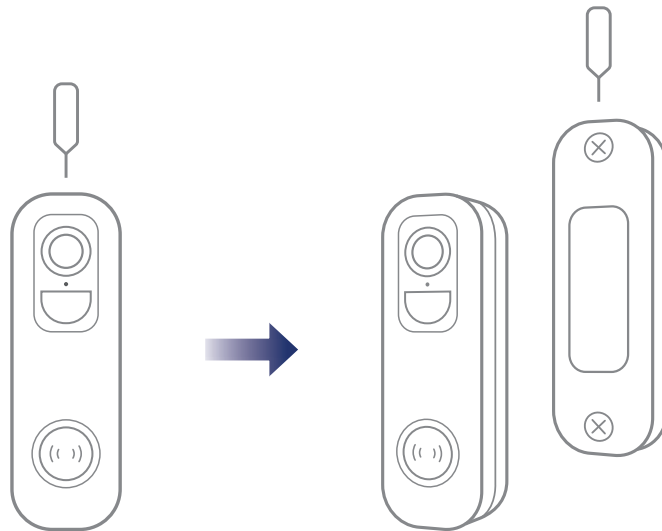

Notes

The iTronBELL is divided into versions with and without electronic tamper. After purchasing the product, you can distinguish it by observing whether there is a circular magnet on the flat bracket; if there is a magnet, it means that it has an electronic tamper-proof function, and if there is no magnet, it does not have an electronic tamper-proof function;

Choosing a suitable location

You can mount the video iTronBELL on the side wall of a porch or door, or on wooden walls and doors.

After the indoor unit is powered on and paired, it should be placed near a socket that is convenient for power supply. It is necessary to ensure that the device is unobstructed and can be covered by wireless signal.

(1) Selecting a suitable installation location

Please install the iTronBELL in an environment with an unobstructed view and within the coverage area of the WiFi signal.

Please adjust the position appropriately based on the specific situation of your home (it is recommended to install it on the flat wall vertical to the door side at a height of 1.2m-1.5m (48 inch-59 inch) . Leave a distance of 100 mm at the top to provide sufficient space for removal tools)

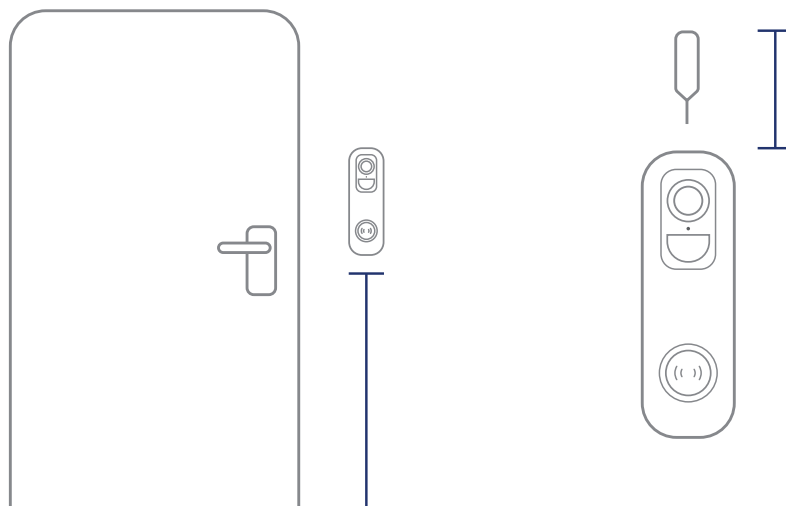

Factors to consider

- ① Check if you can reuse the existing screw holes and expansion bolts on the walls and door frames.
- ② It is recommended that the installation height is 1.2m (48inch) above the ground when you drill the mounting holes for the first time.
- ③ If you want to install the iTronBELL on a wooden wall or door, you can mount the bracket directly with screws instead of drilling holes with a drill first.
- ④ If your wall is made of cement, bricks or concrete, you can mark out the screw hole position first, then drill a hole with a 1/4" (6.35 mm) bit, put in the expansion plug, and secure the bracket with screws.

Special Tips

- ① The iTronBELL, indoor unit and router need to be as close as possible (to avoid networking failure due to distance)
- ② The recommended installation height of the iTronBELL is 1.2m-1.5m (48 inch-59 inch) (installation out of the range may compromise performance)
- ③ It should be installed on non-metallic porches and walls (to avoid signal shielding) or affixed to the wall on the door side.

(2) Selecting an installation scenario

The iTronBELL can be installed with or without iTronBELL wire. You may choose the installation method according to the situation in your home;

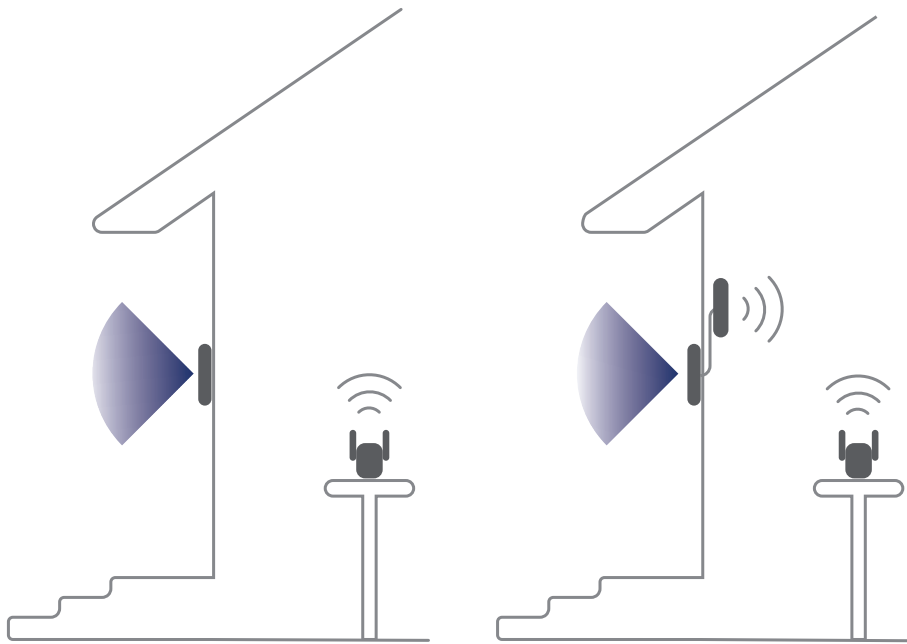

(3) Selecting an installation method

You can use the included 3M adhesive to fix the doorbell, but please ensure that the surface is clean and smooth. First tear off the red sticker on the bottom of 3M adhesive, stick it on the back of the bracket, and then stick the bracket to the installation position you choose. After sticking, press hard to ensure that the paste is firm. To install the doorbell on a rough surface (e.g.: cement wall, brick wall, concrete, and wooden door), screws are recommended to fix the iTronBELL first.

Special Tips

① In order to improve the adhesive effect of the backing, when installing the backing to smooth walls (such as glass, tile, and latex walls), you need to wipe it clean, press evenly and hard, and paste from top to bottom to ensure that the backing is fully activated.

② Please note that the adhesive backing will not be fully sticky until 24 hours after it has been applied.

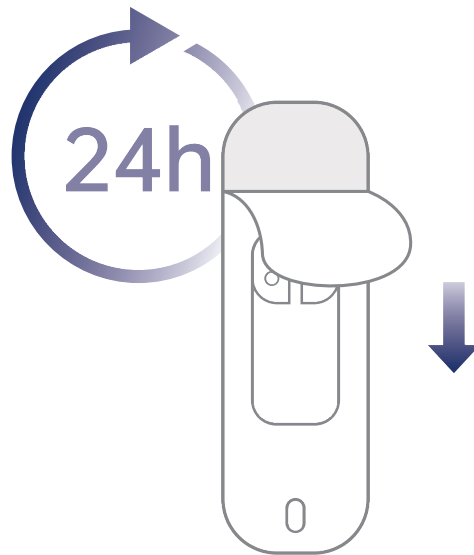

Wireless Installation

1) Installation of expansion bolts and bracket pre-assembly

If you have installed an iTronBELL before, you can install it in the original doorbell location. If you have not installed a doorbell before, you need to measure the installation height in advance and choose a location where the doorbell wire can easily pass through the bracket for installation (using 3M adhesive is also recommended). First use the bracket to mark out the screw hole positions on the wall, remove the doorbell wire (with U-shaped wire clip) from the accessory kit and connect the stripped end to the AC connection wire for pre-fixing;

Use tools such as an electric drill to make holes in the wall or porch, install expansion bolts, and locate the brackets according to the marked positions.

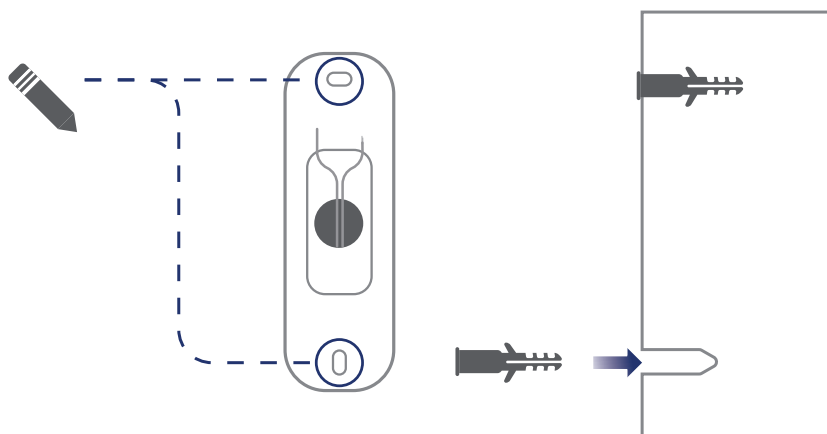

2) Fixing the bracket

Fixing with screws: After the bracket is aligned with the positioning hole, tighten the screws to the wall to fix the bracket with a Phillips screwdriver, and ensure that the installation position is flat and the surrounding environment is not blocked.

Fixing with 3M: Place the bracket with the 3M adhesive attached to the corresponding marked position, and press hard on the bracket to ensure that the paste is firm. During the process, careful alignment is required to avoid problems such as angle deviation, uneven paste, and access difficulty.

3) Fixing the iTronBELL

Install the lower end of the doorbell on the bottom of the bracket, and then snap it into the bracket from bottom to top. When you hear a "click" sound, the doorbell is well installed!

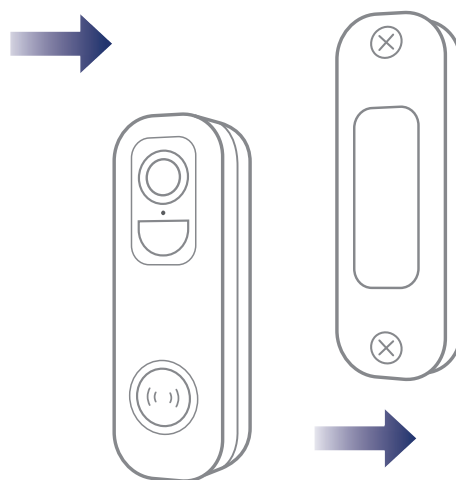

Optional: If you need to see images from different angles, you can use the 20° left and right inclined brackets or 10° up and down inclined brackets as supplementary mounting brackets for installation.

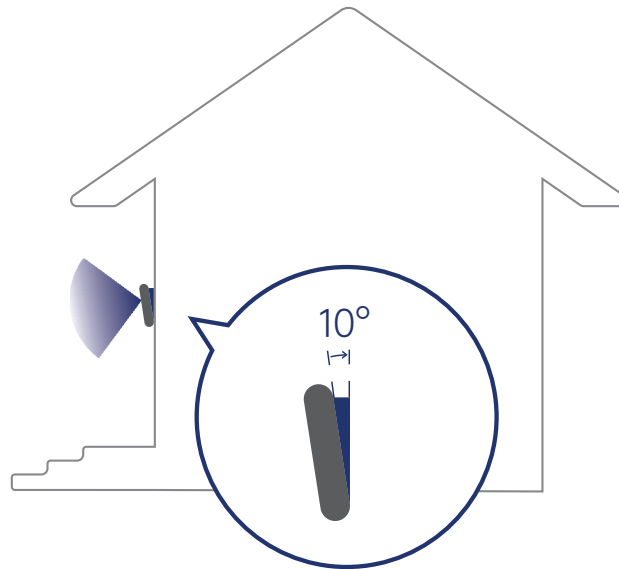

Notes

①The left and right inclined bracket needs to be fixed on the flat bracket by screws and installed on the doorbell. After flipping, it can be changed to a left tilt/right tilt bracket

②The upper and lower inclined bracket need to be installed by replacing the flat brackets on the doorbell. After inversion, it can be transformed into an upward/downward tilt bracket

Optional Power: the doorbell can be powered with a permanent power supply (8V-24V AC @ 20 VA) in some cases connect to an existing doorbell that you already have, if it is a mechanical doorbell, it may even ring the existing bell. More Info refer to "existing doorbell to trigger via iTronBELL"

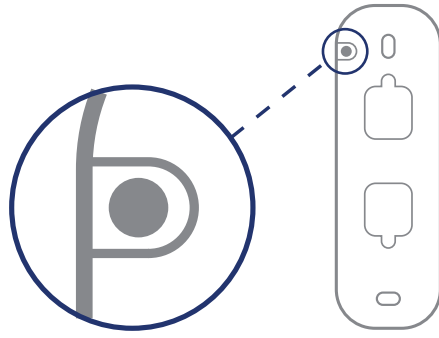

Power On/Off and Network Configuration

Press and hold the power button for 3 seconds when removing the iTronBELL bracket to switch the device on and off. Double click the power button to hear the prompt tone for scanning the QR code and enter the network configuration mode.

! When connecting to the iTronBELL for the first time, please use the App and follow the prompts to configure the doorbell network environment.

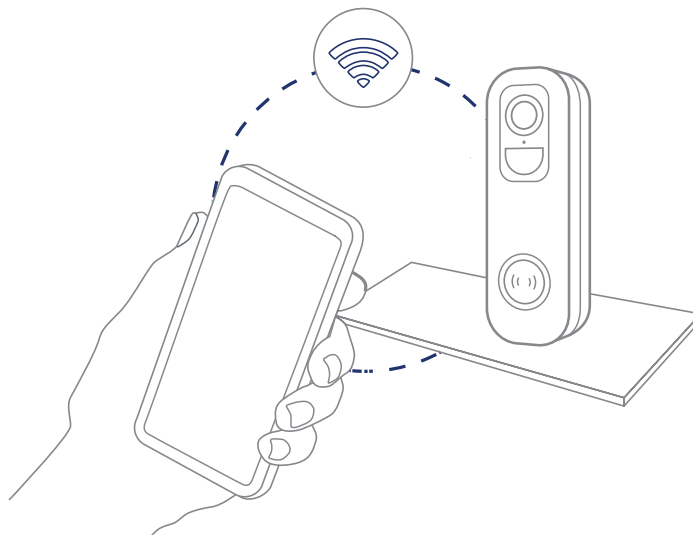

Adding iTronBell to iTronCAM APP

1) Click the Add Now button in the App, press and hold the doorbell switch button for 3 seconds to turn on the doorbell, and the App will automatically search for devices that are on and not bound. Select the device you want to bind in the search results for the next step.

(Picture, schematic diagram of App search device screen)

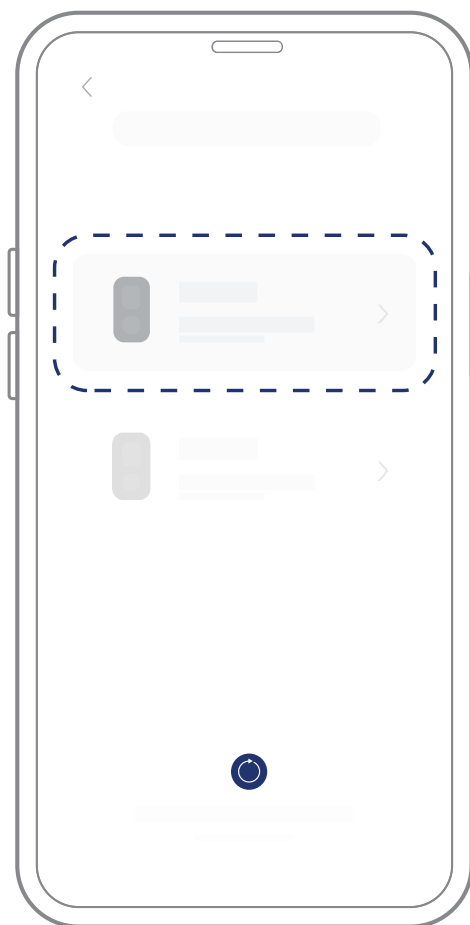

2) Enter the name and password of the Wi-Fi network you want the doorbell to connect to. In order to ensure long-distance connection, the doorbell only supports 2.4 Ghz Wi-Fi network with stronger wall penetration capability, and does not support Wi-Fi with enterprise-level authentication. Please make sure that the Wi-Fi meets the requirements, click Next after completion, and the App will try to connect the doorbell to the Wi-Fi.

(Picture, schematic diagram of AppWi-Fi input screen)



3) After a while, the doorbell will play a sound indicating that the connection is successful. At this point, please set a name for the doorbell on the App and select the location where you want to place the doorbell. Click Finish to complete the pairing.

❗ Possible problems with binding:

- When you hear "**Password error**", check if the Wi-Fi password you entered in the App is correct;
- When you hear "**Authentication method error**", please make sure that your Wi-Fi network is not in an enterprise-level network connection method, as the doorbell only supports networks with a security level below WPA-2;
- When you hear "**AP does not exist**", please check if you have selected or entered the correct Wi-Fi name. Please place the doorbell near the Wi-Fi router and make sure the router is powered on. Also, please note that 5 Ghz Wi-Fi cannot be searched by the doorbell either;
- When you hear "**IP acquisition timeout**", it means that you have too many devices connected to the router. To connect more devices, please delete some infrequently used devices or reboot the router to clear the unconnected iTronBELL. You may need to contact the router administrator if problems persist.

- When you hear "**Server connection failed**", please check if your router is properly connected to the external network. This is usually the case when your home network is disconnected or the router you choose is a server on the LAN. Please make sure the network connection is normal, and try to connect again by temporarily turning off the firewall.

iTronBell Sharing

You can use this feature when you need to use the iTronBell with other family members or friends. Only the admin user who has bound the doorbell for the first time can share and set up the doorbell, while other members can only view the live or playback function of the doorbell.

- 1) Find the iTronBell you wish to share on the App homepage or doorbell settings screen, find the button and enter the sharing screen.
- 2) Click "Invite Friends" and a sharing QR code will be generated.
- 3) For the member you want to share, you can enter the scanning screen by "Add friend's device" in their "My" screen.
- 4) After the QR code on your phone is scanned successfully, you will receive a confirmation notification. You can share it with your consent.

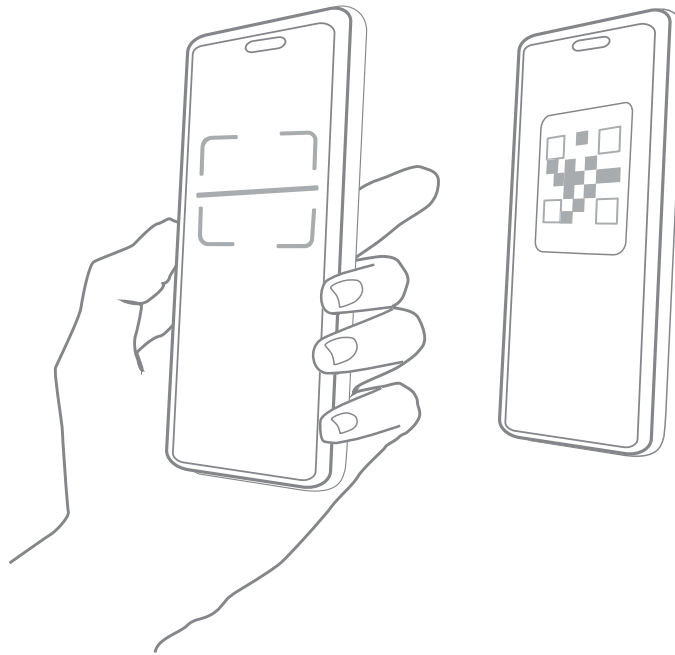

iTronBell Charging

When the battery is low, the App will prompt you to charge it. Please refer to the doorbell tamper-proof method, remove the doorbell from the bracket with the tamper-proof tool, and use the micro USB cable to plug in the 5 V/1.5 A charging adapter to charge the doorbell. During the charging process, the yellow indicator light of the doorbell is always on, and the indicator will become solid green when the charging is completed. It may take about 10 hours to fully charge the doorbell.

iTronBELL indicator status

Mode	Status
Working mode	Solid blue light
Sleep mode	Indicator off
Charging mode	Solid yellow light
Charging mode completed	Solid green light

Indicator status of the indoor unit

Mode	Status
Waiting for pairing	The Blue light flashes every 1 sec
Pairing code received	The solid blue light goes out when the ringing ends
Doorbell ringing received	The solid blue light goes out when the ringing ends

Wired Installation / Existing Bell Trigger

This doorbell does not support electronic Ding Dong chimes. The list of mechanical Ding Dong models it supports is as follows:

S/N	Brand	Model
01	NuTone	LA139WH-1
02	newhouse Hardware	H5
03	NuTone	LA11WH
04	Heath Zenith	B3E521
05	NuTone	LA-126WH
06	Honeywell home	D3230
07	Honeywell home	D117

Other mechanical Ding Dong models will soon be available...

When pairing it with mechanical DingDong chimes, you can control the chime through the doorbell power cord (8V-24VAC with power out put of 20VA). In order to get enough power from the doorbell circuit, you need to bypass the indoor unit in the set to access.

1) Mains Power off

Before connecting the doorbell wire to the terminal, please disconnect the power through the breaker in your house, which will ensure the safety of yourself and the device

If there is no indicator label for the breaker on the line where the doorbell is located, try pressing the old doorbell to make sure the power is off.

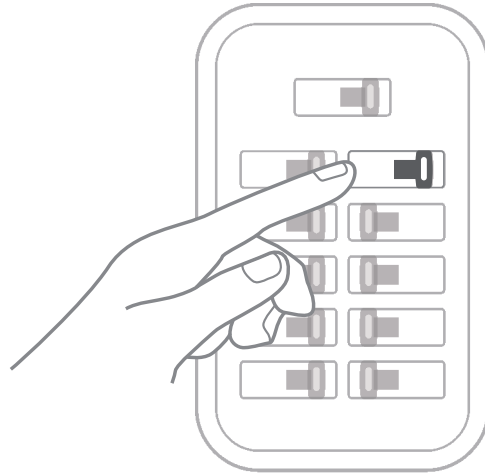

2) Removal of the old doorbell

Before installing the doorbell, please use a Phillips screwdriver to remove the old doorbell from the wall or door and remove all other hardware. If your old doorbell is also a visual doorbell, please be sure to remove all connectors, as the connectors on the old unit may not work with this product.

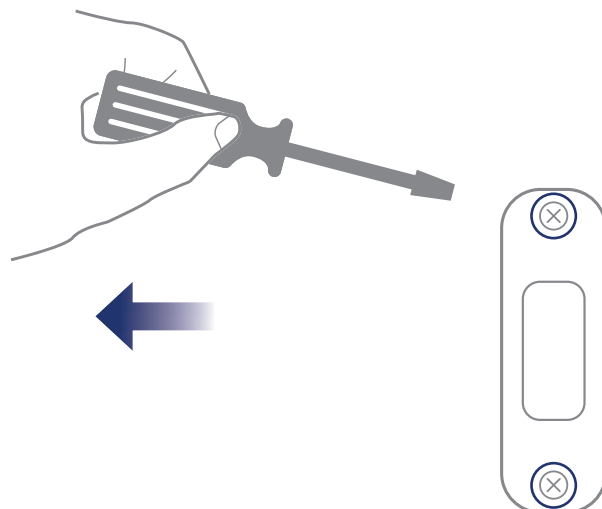

Disconnect the cable from the old doorbell and make sure it does not fall into the hole;

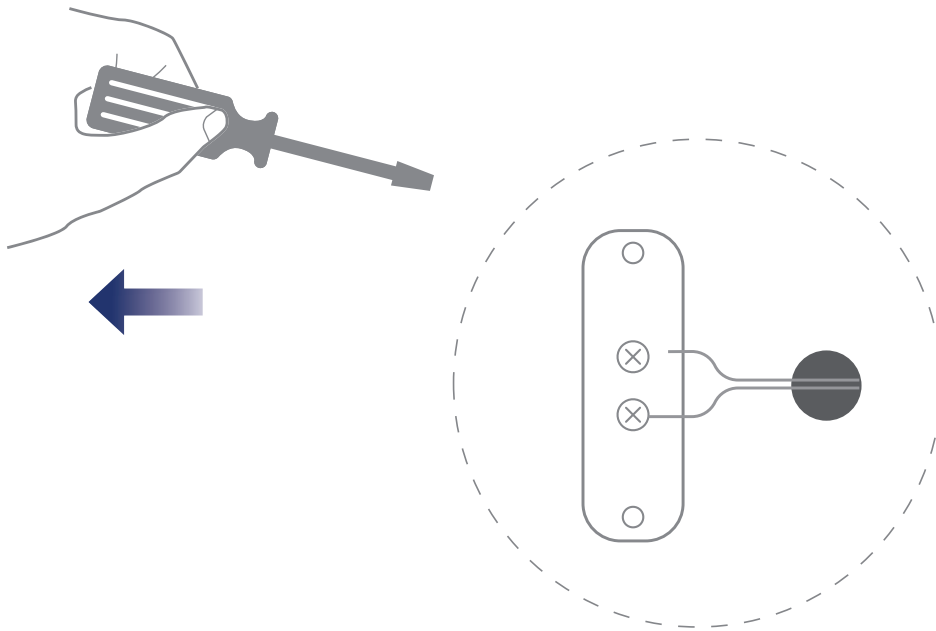

3) Installation of expansion bolts and bracket pre-assembly

If you have installed a doorbell before, you can install it in the original doorbell location. If you have not installed a doorbell before, you need to measure the installation height in advance and choose a location where the doorbell wire can easily pass through the bracket for installation (using 3M adhesive is also recommended). First use the bracket to mark out the screw hole positions on the wall, remove the doorbell wire (with U-shaped wire clip) from the accessory kit and connect the stripped end to the AC connection wire for pre-fixing;

Use tools such as an electric drill to make holes in the wall or porch, install expansion bolts, and locate the brackets according to the marked positions.

4) Fixing the bracket & connecting the doorbell wire

After the bracket is aligned with the positioning hole, tighten the screws to the wall to fix the bracket with a Phillips screwdriver, pass the doorbell wire through the bracket, connect the doorbell wire and the AC connection and insulate. Loosen the connecting screws and snap the doorbell wire to the two terminals on the back of the doorbell, and tighten the terminal screws with a Phillips screwdriver; with AC current, the wires can be connected to any terminal.

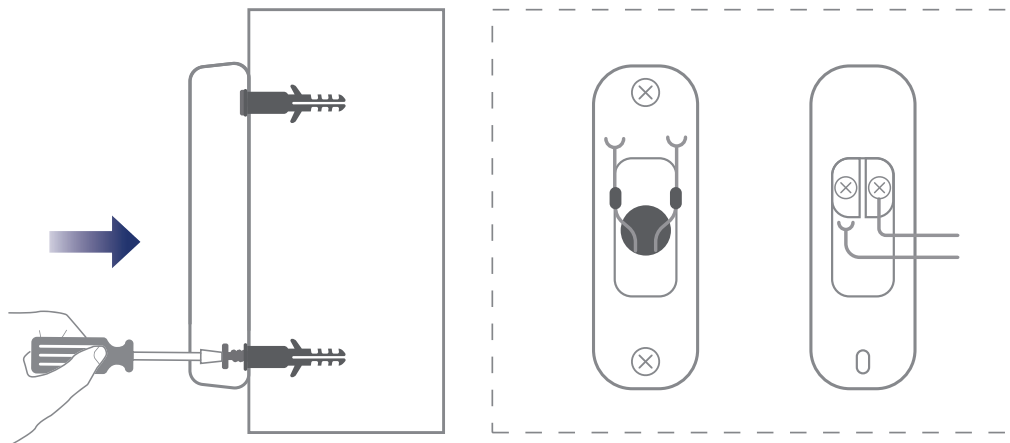

Notes

To prevent short circuits, make sure the wires do not touch each other after connecting to the terminals. If the wires are too short, use extension cords and terminal caps for extension and protection. If the wall does not have room for a wire nut, use an electrical tape to insulate and secure the connection.

5) Connecting the AC line of the mechanical Ding Dong chimes

If you need to install a new mechanical Ding Dong chime, prepare the required device, and refer to the installation guide of the purchased device for wiring. Some models can also be installed by referring to the conventional wiring methods of mechanical Ding Dong chimes as follows;

Remove the cover of the mechanical Ding Dong, put it aside, loosen the screws on the "Front" and "Trans" ends, and snap the AC cable to the "Front" and "Trans" terminals of the mechanical Ding Dong, and then tighten the terminal screws with a Phillips screwdriver; with AC current, the wires can be connected to any terminal.

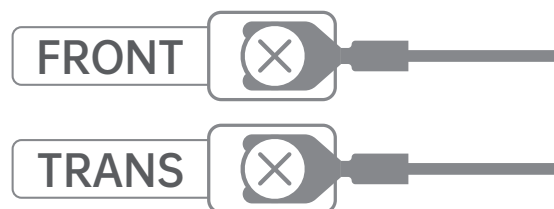

6) Fixing the doorbell

Install the lower end of the doorbell on the bottom of the bracket, and then snap it into the bracket from bottom to top. When you hear a "click" sound, the doorbell is installed!

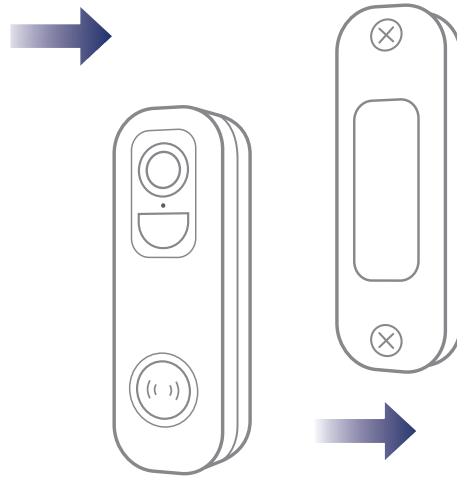

7) Power on the doorbell

Power on the breaker at your home. The doorbell is ready for use

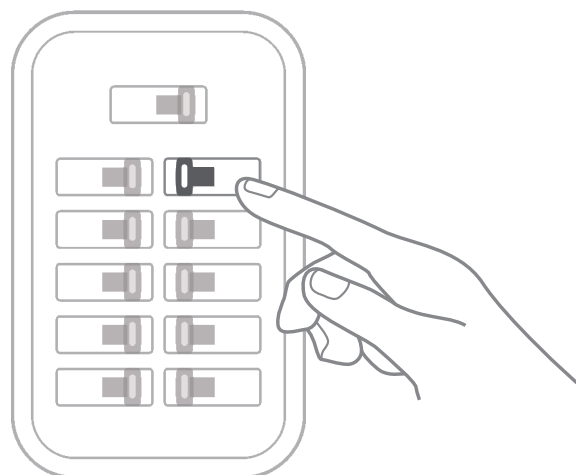

Specification of indoor unit

Item	Specification
Power port	Micro USB
Ringtone type	Chord music
Number of ringtones	5
Communication protocol	FSK
Adapter requirements	5V/1A
Dimension	65×65×20(mm)

Product Specification

Item	Specification
Doorbell camera	FOV 160°
Image resolution	Up to 2048 × 1536
Video bitrate	Adaptive

Item	Specification
Storage medium	Micro SD card (up to 128 GB)
Battery capacity	5200 mAh
Adapter requirements	5V/1.5A
Dimension	144×46×31(mm)

Firmware Upgrade

When you connect your doorbell via the App, it will automatically detect if there is new firmware available for your doorbell and prompt for an upgrade when there is a firmware update. You can also manually detect the firmware upgrade in the App's doorbell settings.

! Please make sure your doorbell is fully charged or connected to the power adapter before the firmware upgrade, and do not turn off your doorbell during the upgrade process.

FAQ and Troubleshooting

Q: Doorbell permission distribution management: How can I invite my family and friends to use my doorbell together?

A: Open the App, select your doorbell in the main menu, click the share button in the main interface or "Share" in the doorbell settings, enter the sharing screen and click "Invite Friends" to generate QR code. Your friends can scan the QR code through the "Add Friend's Device" in Add Doorbell to get partial access.

Q: How come the network name is not displayed when I connect to Wi-Fi?

A: For Apple devices with iOS13 or above, you need to enable "Location Permissions" and set it to "Allow While Using App" for the App in the system settings.

Q: Does the doorbell glow red when using its night vision?

A: It has built-in infrared LEDs. Only a faint red light can be seen under night vision, and it is still clear in dark environment.

Q: What are the requirements for Wi-Fi?

A: Please use a 2.4 G wireless network. The doorbell does not support 5 G wireless network. Meanwhile, please set the Wi-Fi authentication method to a security method below wpa2-psk, which requires a password.

Q: How far away from the router should the doorbell be placed?

A: It has been tested that the Wi-Fi connection distance is up to 150 meters in an open environment. The actual situation depends on the Wi-Fi signal strength and the surrounding environment (too thick walls, electromagnetic wave doorbell, large metal objects can interfere with the Wi-Fi signal). If the doorbell connection signal is weak or unstable, please place the doorbell as close to the router as possible.

Q: What is the maximum length of video it can record?

A: You can choose the length of the recorded video in the App. If you choose Auto, it will continue to record up to 3 minutes of video from the time someone is in the view until the person walks out of the view.

Q: How can I review videos in a quick and categorized way?

A: Click the icon on the top left corner of the "Album" screen to set filtering conditions, check the conditions and save them to quickly review the video playback by category.

Q: What should I do when the doorbell is not functioning?

A: After taking the doorbell off the bracket, press and hold the power button for 3 seconds to reboot it. If it doesn't respond, you can reset the doorbell by pressing the reset hole with a pin.

Q: I still have issues with my system ?

A: Please contact your local store or the distributor in your region.



iTronCAM.... AI Smart CCTV Camera is also available to purchase which is compatible with the same APP
Contact your Local supplier or visit www.iTronCAM.com

www.iTronBELL.com
New Zealand