

# Simple Installation Guide

Complete 8/248 input security & control kit

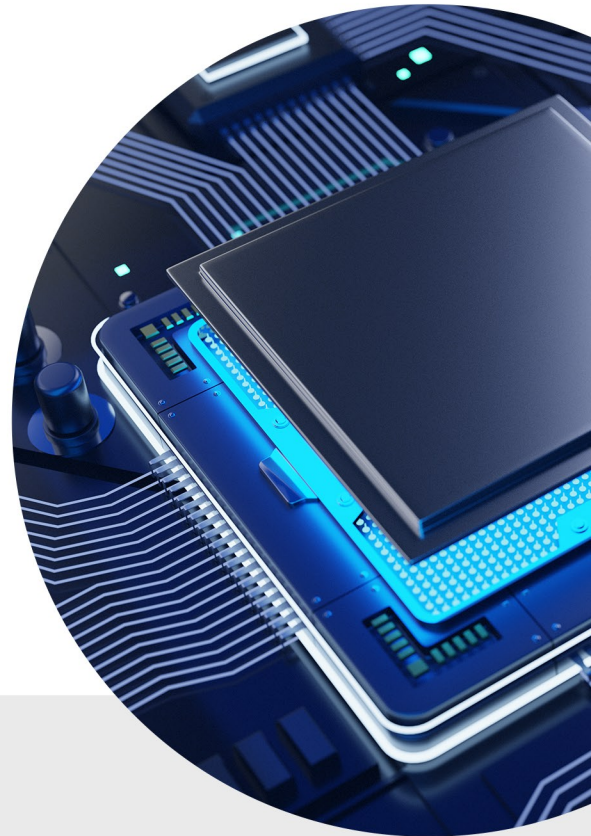

## Options & Accessories

**EliteCloud APP**  
[www.elitecloud.co.nz](http://www.elitecloud.co.nz)



**Monitoring**  
Ethernet or optional PSTN

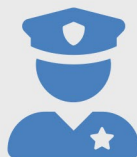

**Long Range Wireless**  
infinity series



**Dashboard**  
(coming soon)



**Integrated Access Control**  
Up to 32 doors



**EliteCloud Information**  
Videos    Information



## EC-PCB Specifications *(All lines marked \* require extra hardware)*



Specification	Description
<b>Ethernet *</b>	Supports smartphone app, local web browser, monitoring to central station & cloud dashboard (coming soon)
<b>Smartphone App *</b>	Compatible with EliteCloud smartphone app for Apple & Android devices.
<b>Management *</b>	EliteCloud programming & management dashboard coming soon - elitecloud.co.nz.
<b>Web Browser *</b>	Local web browser programming for configuration without internet.
<b>Inputs - Wired</b>	8 (onboard), expandable up to 248 with modular EC-Z8 input expanders.
<b>Inputs - Wireless *</b>	Supports 'infinity motion' PIR detectors &/or 'infinity input' reed switches.
<b>Wireless - Hardware *</b>	Supports wireless infinity link, motion, remote, input, output, panic & siren.
<b>Outputs - Wired</b>	4 (onboard), expandable up to 32 with modular EC-O4 output expanders.
<b>Accessory Power</b>	13.8VDC 1A fused.
<b>Outputs - 1 &amp; 2</b>	Monitored 12V outputs designed for hardwired external & internal sirens.
<b>Output - Relay</b>	Output 4 is a clean relay contact designed for garage doors & gates.
<b>Outputs - Wireless</b>	Supports up to 32 x 'infinity output' wireless relay modules.
<b>Keypads - Max</b>	Supports up to 32 x Alarm &/or access control keypad/readers.
<b>Keypad - Bus</b>	High speed EliteControl bus
<b>Alarm Keypad Options</b>	EC-KP, EC-TOUCH, EC-LCD & EC-LCD PROX
<b>Keypads/Readers *</b>	PW WIEGAND, PW WIEGAND NK, PW WIEGAND SK1, PW WIEGAND SK4 & more.
<b>Areas/Partitions</b>	32 Partitions, each with a dedicated stay/night arm.
<b>Schedules</b>	32 time schedules for automatic operations or restrictions.
<b>Users - Codes</b>	2000 user codes for alarm or access control functions.
<b>Users - Wireless *</b>	Up to 1900 - Wireless users/remote buttons are added from users 101 to 2000.
<b>PSTN Dialler *</b>	Available with additional plug in PSTN dialler module.
<b>Battery Back Up</b>	Dynamic battery monitoring with low voltage disconnect.
<b>Battery Charging</b>	250mA current limited SLA battery charging with over current protection.
<b>Power Supply</b>	Built in 13.8V, 1.5A switch mode power supply.
<b>Tamper</b>	2K2 EOL or zero resistance to ground (programmable).
<b>Keyswitch</b>	Supports up to 248 keyswitch inputs. Each takes up 1 of the 248 available inputs.
<b>Update Config *</b>	Available via EliteCloud dashboard (coming soon) or inbuilt web browser.
<b>Backup Config *</b>	Available via EliteCloud dashboard (coming soon) or inbuilt web browser.
<b>Firmware Update *</b>	Available via EliteCloud dashboard (coming soon) or inbuilt web browser.

## Important

All 'EC' & infinity series products are to be installed by a 'Skilled person' and must have training or experience in this equipment technology. A skilled person is expected to use their training or experience to identify energy sources that may cause pain or injury and take appropriate action to prevent unintentional harm to themselves & others

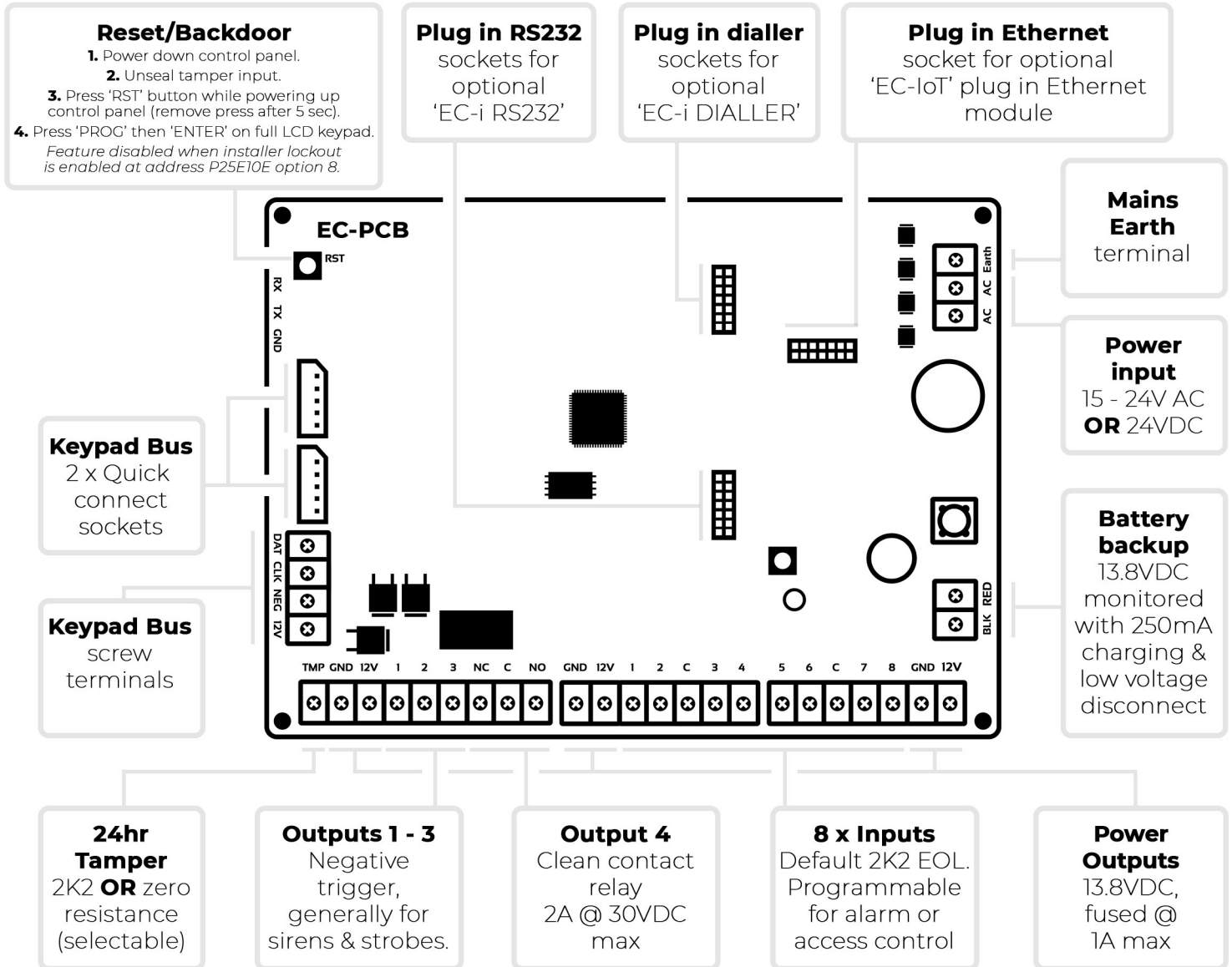

## Bus Support

- **Max Cable Length** (0.44mm 4 core Security Cable) - 300m maximum combined bus length.
- **Alarm Keypad Support** - EC-KP, EC-TOUCH, EC-LCD & EC-LCD PROX.
- **Wireless Support** - 1 x 'infinity link' required to support full infinity wireless product range.
- **Expander Support** - EC-O4, EC-Z8 & EC-A2.
- **Access Control Modules** - EC-A2 & WIEGAND MINI.

## EC-TOUCH



EC-LCD

## EC-PCB Hardware Connection Overview

**RS232**  
(Not standard fitment)  
Optional plug in module available.

**Ethernet**  
'EC-PCB' requires plug in EC-IoT module to support web browser programming, alarm reporting, EliteCloud APP & EliteCloud dashboard (coming soon).

**Bus Sockets**  
For infinity link or ARR14/ARR15 quick connect bus cables.



Internal Siren

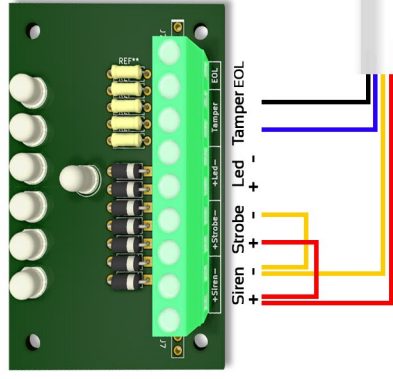

EC-SIREN

External Siren

Wiring the external siren tamper is not required, however if not wired you must add a link wire or 2K2 resistor. Programmable at address P25E10E

Automatic Garage Door

Push Button Input

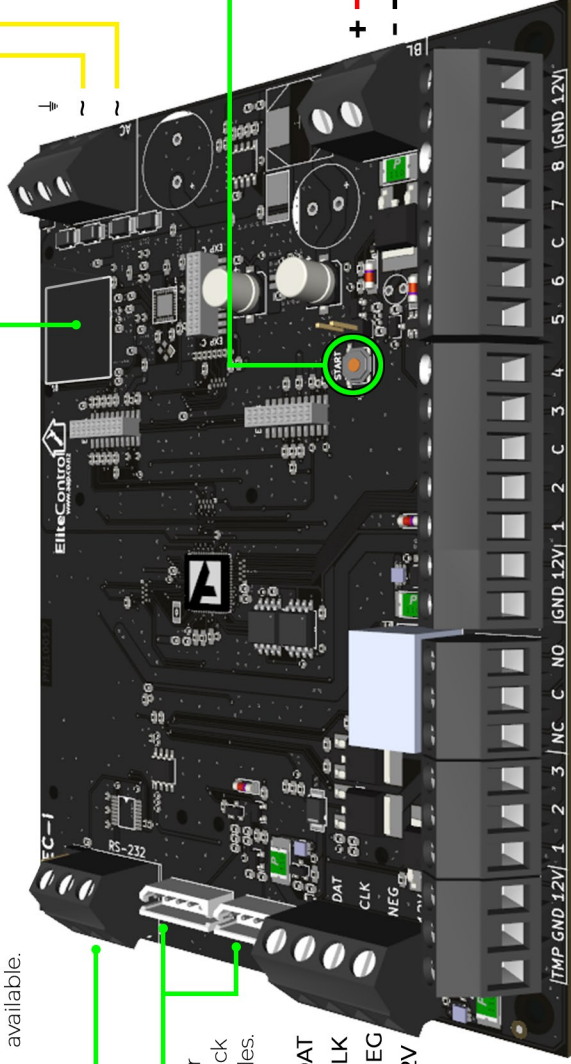

15 to 24VAC out

230VAC in

12V SLA Back up Battery

**AC To Start Battery**  
(Ideal for sites where AC is not available during installation)

After commissioning the system via battery power only, this button will disconnect the battery power until AC is connected to the control panel by the electrician.

Once AC is connected, the battery circuit will then continue to operate as per normal.

One of 3 accessory power outlets, all protected by a shared 1A PTC fuse.

Seal unused inputs with a 2K2 resistor as shown.

**EC-PCB Standard EOL Resistors:**

2K2 = [Red, Red, Red, Gold]

4K7 = [Yellow, Violet, Red, Gold]

**2K2 single EOL is the default EC-PCB setting.**  
2K2 + 4K7 (and other configurations) can be used for input + tamper (for example).  
See P125 in the full manual for more information.

Generic

PIR Sensor 1

Generic

PIR Sensor 2

## **EC-PCB Built in Web Browser** *(requires optional 'EC-IoT' Ethernet module)*

Web browser is the best way to program the control panel for installations where internet is not available.

## **Security for Off Site/Remote Connection**

It is not recommended to port forward the built in web browser for off site configuration as this is not secure & the system could easily be compromised. Use the EliteCloud dashboard for off site access with any EC-PCB, EC-i, ESL, ESL-2 or Runner control panel. EliteCloud provides a secure end to end encrypted connection from almost anywhere.

## **Default IP Address**

- 192.168.1.100 is the default IP address for the control panel, however **DHCP is on by default** so this will change if plugged into a router/switch.

## **Retrieving IP Address**

- You can view/retrieve the control panel IP address by pressing and holding the '9' button on the 'EC-LCD', 'EC-LCD PROX' or 'EC-KP' keypads **OR** by pressing 'TCP/IP Address' within the service menu on the 'EC-TOUCH' screen.

## **Connecting**

- Once you know the current system IP address you can connect directly to the built in web browser with a patch cable by setting your computer IPV4 to the same range as the control panel.
- Alternatively you can set your computer IPV4 to DHCP/Automatic and connect through a router or switch.
- Once one of the 2 steps above are complete, open your computer web browser and enter the IP address followed by enter to confirm & the 'Log in' page shown below should appear.

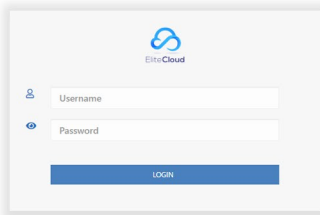

## **Signing In**

- Users from 1 to 32 can be used to sign into the web browser. For this you will require the user name & code as programmed into the control panel.
- For example: Default 'User 1' name & password is: Name: User 1 Password: 123
- Enter the correct user name & password into the login fields and you will be directed to the 'Status & Control' page as detailed below:

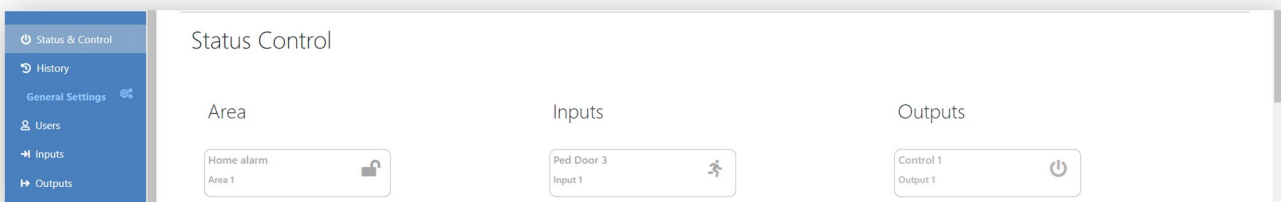

## Simple Programming

### → | Entering Installer mode

#### EC-LCD & EC-LCD PROX

Press 'PROG' followed by your installer code (default - 000000), then press 'ENTER'. You should now see 'Installer: Users' on the keypad display.

#### EC-TOUCH

Press 'Settings', followed by your installer code (default - 000000), then press the tick icon to confirm. You should now see 'Installer Settings' Menu.

### ← | Exiting Installer Mode

**EC-LCD & EC-LCD PROX** - Press 'PROG' (once or twice) until you see '<ENTER>' to exit'. Then press the 'ENTER' button.

**EC-TOUCH** - Press the back button '<' until you return to the home screen.



### Changing/Adding User Codes

- To change user codes you must be in 'Installer mode' or 'Client Mode'.
- The EC-PCB panel has the ability to store up to 2000 user codes.
- User codes can be anywhere from 1 to 6 digits long & require the 'ENTER' button to be pressed after code entry.
- User codes are programmed at Address 1 & then entered into slots from 1 to 2000 as detailed below.

Press 'PROG' '1' 'ENTER' then the slot you wish to change i.e. '1', then press 'ENTER'. The keypad will flash back or display the current code (default code is 123). Now enter your new code i.e. 4 5 6 then press 'ENTER' to confirm. The new code (456 for example) will flash back or display on the screen.

Below are some examples of adding user codes where 'P' represents 'PROG' & 'E' represents 'ENTER'.

P1 E 1 E [ ][ ][ ][ ][ ][ ] E (This is the master code default = 123)

P1 E 2 E [ ][ ][ ][ ][ ][ ] E

P1 E 3 E [ ][ ][ ][ ][ ][ ] E



### Changing Installer code

There is only one installer code which can only be used when the system is disarmed. To change the installer code simply enter installer mode, then press 'PROG' '25' 'ENTER' '1' 'ENTER' and the current code will be displayed. Now enter your new installer code from 1-6 digits and press 'ENTER' to confirm

P25 E 1 E [ ][ ][ ][ ][ ][ ] E



### Changing Entry delays

This is how long a sensor gives you to get in and disarm the system after it has been triggered. Each sensor has its own delay from 0 to 9999 seconds. If you have to pass a sensor to get to the keypad then it must have an entry delay. In installer mode press 'PROG' '144' 'ENTER' then select the input you wish to change (1 to 248) and press 'ENTER'. Now enter the new time (0 to 9999) in seconds and press 'ENTER'. The new entry delay time should display on the screen

P144 E 1 E [ ][ ][ ][ ][ ][ ] E (Default delay for zone 1 = 20 seconds)

P144 E 2 E [ ][ ][ ][ ][ ][ ] E (Default delay for zone 2 = 0 seconds)



### Changing Exit delay

This is how long you have to get out of the premises after pressing an 'Arm' button. This time is programmable from 0 to 255 seconds. In installer mode, press 'PROG' '60' 'ENTER' '1' 'ENTER', now enter the selected time from 0-255 seconds, followed by the 'ENTER' button to confirm

P60 E 1 E [ ][ ][ ][ ][ ] E (Default time = 30 seconds)



# Changing Time, Day & Date



## Enter installer Mode

### Time

P 26 E 1 E (24hr Time) E

### Day

P 26 E 2 E (Day) E - Sunday = 1, Monday = 2, Tuesday = 3, Wednesday = 4, Thursday = 5, Friday = 6, Saturday = 7

### Date

P 26 E 3 E (Date) E - DD/MM/YY

---

## System Test



When the programming configuration is complete, a quick test is required to confirm all hardware and software is working correctly. Run through the steps below to make sure the system is operating as required.

Make sure no one is moving around the premises as this could affect the test.

**1 - The keypad should not have any input lights on.** If input lights are present, make sure:

- Your wiring is correct as per page 4.
- The resistors in the sensors are correct - RED, RED, RED, GOLD (unless using non default EOL configuration).
- You have used the 2K2 resistors provided to seal any unused inputs (or turned them off in programming).
- That all covers are correctly placed on sensors.

### 2 - Sensors Walk Test

- Enter install mode (as per page 6) then press P 200 E 6 E E to enter walk test mode & the keypad should start beeping. Now walk in front of each sensor and when you get back to the keypad the inputs that are working correctly will permanently display on the keypad. If some sensors are not working, do the following:
- Check your wiring is correct as per page 4.
- Check the resistors in the sensors are correct - RED, RED, RED, GOLD (unless using non default EOL configuration).
- That all covers are correctly placed on sensors.

### 3 - Test all of the user codes

- Start by typing in user code 1 followed by the 'ENTER' button and the keypad should start beeping as it arms.
- Now type user code 1 in again, followed by the 'ENTER' button and the keypad should go quiet as it disarms. Repeat this test for all of the user codes you have programmed.
- Are all user codes operating correctly? If not, please revisit 'Changing/Adding User Codes' on the previous page.

### 4 - Press the ARM button to see if there is enough time to get out of the house before the exit delay beeps stop

- If not you will need to extend the exit delay as per 'Changing Exit Delay' the previous page.

### 5 - Now with the system armed, see if you can get back inside to the keypad and disarm the alarm before the sirens go off

- If not you will need to increase the entry delay time/times as per 'Changing Entry Delays' on the previous page.

### 6 - Make sure the sirens and strobe go off after the entry delay expires

- Arm the system, wait for the beeps to stop then move in front of a sensor. The keypad should start beeping again and as soon as the entry delay is finished the sirens and strobe should go off. Once the sirens have been checked, enter an active user code followed by the ENTER button to disarm the system.
- Does the external siren & strobe operate when the system is in alarm? If not, recheck wiring as per page 4.
- Does the internal siren work? If not, recheck wiring as per page 4.

---

## Reference Material



Program  
Summary  
Guide

[www.aap.co.nz/summary](http://www.aap.co.nz/summary)



Access  
Control  
Manual

[www.aap.co.nz/access](http://www.aap.co.nz/access)



User  
Manual

[www.aap.co.nz/user](http://www.aap.co.nz/user)



PowerPoint  
Training  
Presentation

[www.aap.co.nz/training](http://www.aap.co.nz/training)

# EliteCloud Smartphone APP *(requires 'EC-IoT' Ethernet module)*

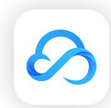

## Important Information

- The APP is 'Keypad address 8' on the EC-PCB control panel. I.e. APP functions such as Arm/Disarm & output control need to be mapped or programmed as Keypad 8.
- Arming/Disarming areas from the APP is directly related to User codes/permissions. I.e. Each area that you wish to Arm/Disarm independently from the APP needs it's own User code.
- Each user must have their own EliteCloud account. I.e. You can not use the same email across 2 different Users/Smartphones.

## App & Site Setup

It is recommended to test each site on your own smart device before giving ownership to the site owner. See steps below for 'Adding Users' & 'Transferring Ownership'.



### Download the EliteCloud App

Search EliteCloud on your smart device store, **OR** scan the QR code below:

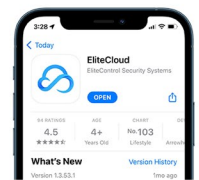

### Sign Up, Sign In & Select a Plan

Open the EliteCloud app, press 'Sign Up' & follow the prompts. This process will ask you to register, verify your email, 'Sign In' & select a plan.

If you already have an EliteCloud account, simply open the app, 'Sign In' & move on to the next step.

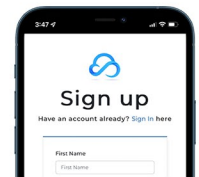

### Adding a Site - *Each Site can only be added/owned by 1 User.*

After pressing 'Add Site' & accepting the T & C, a QR scanner will appear. Use this to scan the QR code found on your 'EC-PCB' control panel. Site ID (MAC & Serial) can also be manually added using the 'Enter manually' button.

Scan the QR code for a step by step video on how to add a site.



### Adding & Inviting Users - *All users must have their own EliteCloud account. See step 2*

Go to the 'Users' list found in the main app menu, then press the 'Invite User' icon. Next you can scan the new users 'Account QR Code' found in their 'User Settings' or manually enter their EliteCloud registered email address.

Scan the QR code for a step by step video on how to invite & manage users.



### Accepting Invitations & Transferring Ownership

New users must accept any site invitations from within the 'Envelope' icon found at the top left of the sites screen. Once accepted the 'Owner' of the site can transfer ownership from within the 'Users' list found in the main menu.

Scan this QR code for a step by step video on accepting site invitations



### Monitoring

IP monitoring via the EC-PCB is configured directly from the EliteCloud app.

This is accessed from within 'Settings' > 'Advanced Settings' > 'Monitoring Configuration'.

### EliteCloud Tutorials

Scan the QR code below to view our EliteCloud & EliteControl tutorial videos.

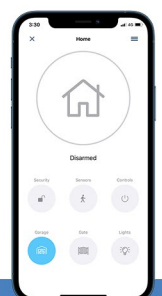



## Wireless Remotes (Optional Accessory)

Remotes & other wireless devices can be added to the EC- PLAS with the additional 'infinity link' transceiver module as detailed below:

### Hardware Connection

Connect the infinity link to the EC-PCB using the ARR14 bus loom provided with the infinity link.

Alternatively, connect the infinity link to the EC-PCB 12V, NEG, CLK, DAT screw down terminals.

Figure 1

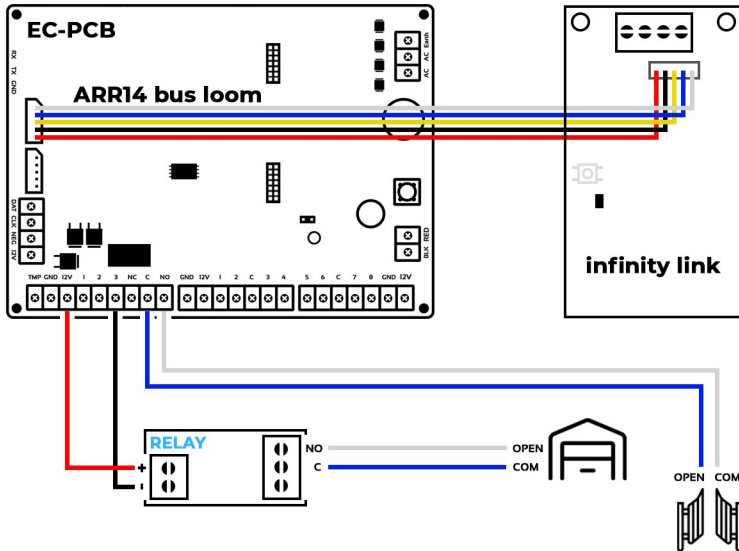

### Garage Doors & Gates

Outputs 3 & 4 on the EC-PCB can be wired to garage doors or gates & controlled by remotes, keypads or the EliteCloud app.

Output 4 is a clean contact so can generally be wired directly, however output 3 may require a separate relay as shown in 'Figure 1'.

### Output Expansion

The EC-PCB supports a maximum of 32 outputs. These can be hardwired, wireless or a mixture of both as detailed below:

#### Hardwired - EC-O4

The EC-O4 is a 4 x relay output expander module that plugs into the EC-PCB bus. Scan QR to find out more:

Full Manual



#### Wireless - infinity output

The 'infinity output' can be learnt into any of the 32 x EC-PCB outputs for controlling doors, gates & more. Scan QR to find out more:

Full Manual



*It is recommended to default each wireless device before learning into a new system.*

### infinity remote Default Procedure

Press & hold button 1 (shown in 'Figure 2') & the LED will display **solid red**

As soon as the **solid red** LED turns off, keep holding button 1 while pressing button 2, then 4, then 3 in quick succession.

After pressing the last button (button 3), a **green LED** should display to confirm that the default has completed successfully.

Figure 2

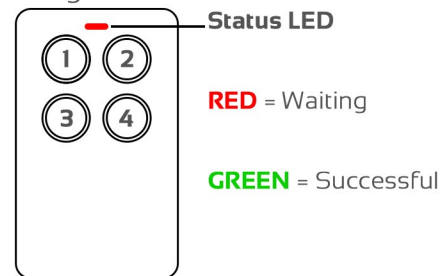

### infinity link Default Procedure

Press and hold the gold 'Default Button' shown in 'Figure 3' while powering up the infinity link & continue to hold.

The LED will display **solid red** and **turn green** when default is successful.

**Warning:** Defaulting the infinity link will lose connection with all previously paired products.

Figure 3

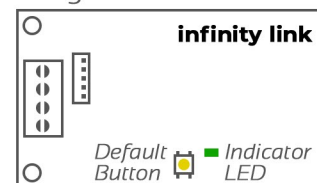

### infinity link Indication LED

The indication LED shown in 'Figure 3' will illuminate **green** when receiving a wireless signal & also flash during system learn beeps.

## Learning Remotes *(consult control panel installation manual for advanced programming)*

'EC' control panels have pre-configured user slots to simplify learning of wireless remotes. These slots are located from users 140 to 189 as shown in 'Pre-Configured User Slots' table below:

- Enter installer programming mode on the alarm keypad.
- Press PROG 18 ENTER followed by the user number you wish to learn (eg. 140), followed by ENTER. Next press ENTER again to start the keypad beeps which indicates that the system is waiting for a remote button to be pressed.
- Press the remote button you wish to learn and the keypad should stop beeping to indicate a successful learn.
- To learn another button, press the right or left arrows on the keypad to go to next or previous user slot, then press ENTER, or press PROG then ENTER to exit installer programming.

### Pre-Configured User Slots



#### Users 140 to 149 will ARM only

Example: P 18 E 140 E E (learn beeps start) Press the remote button you wish to learn (learn beeps stop)  
This button will now ARM the system

#### Users 150 to 159 will DISARM only

Example: P 18 E 150 E E (learn beeps start) Press the remote button you wish to learn (learn beeps stop)  
This button will now DISARM the system

#### Users 160 to 169 will operate OUTPUT 3 & DISARM at the same time

Example: P 18 E 160 E E (learn beeps start) Press the remote button you wish to learn (learn beeps stop)  
This button will now DISARM the system & control output 3 at the same time

#### Users 170 to 179 will operate OUTPUT 4 & DISARM at the same time

Example: P 18 E 170 E E (learn beeps start) Press the remote button you wish to learn (learn beeps stop)  
This button will now DISARM the system & control output 4 at the same time

#### Users 180 to 189 will operate as a PANIC button

Example: P 18 E 180 E E (learn beeps start) Press the remote button you wish to learn (learn beeps stop)  
This button will now perform a PANIC function

#### Remote 1 Example *(button colours are indicative only)*

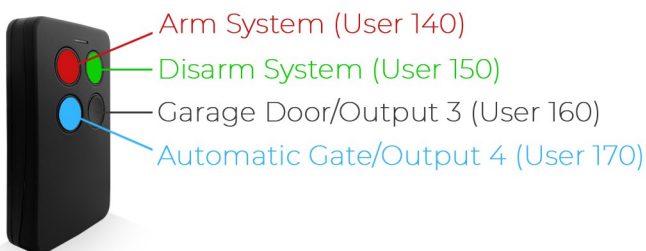

#### Remote 2 Example *(button colours are indicative only)*

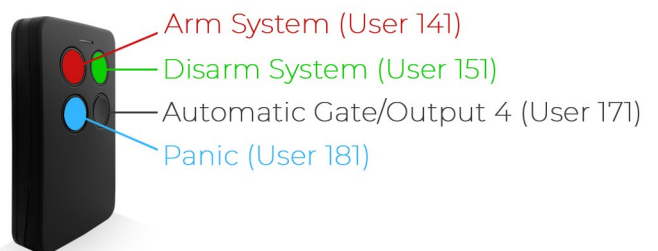

### Battery Low Reporting & Haptic Feedback

- P 7 E must be set to option 1 (infinity) to enable battery low reporting & for the remote to operate correctly.
- Haptic feedback is disabled when battery low is reported due to the remote entering power save mode.
- Battery low will be indicated to the control panel at 2.2V & below.

## Cabinet & Transformer Specifications & Installation Requirements

- This product **must be installed by a 'Skilled person'** who has training or experience in this equipment technology. A skilled person is expected to use their training or experience to identify energy sources that may cause pain or injury and take appropriate action to prevent unintentional harm to themselves & others

### Specifications

<b>Manufacturer</b>	Arrowhead Alarm Products Ltd.
<b>Product Name</b>	EC-CAB 1A.
<b>Input Voltage &amp; Frequency</b>	230 ~ 250VAC - 50Hz.
<b>Rated Current</b>	150mA .
<b>Transformer Output Voltage</b>	17VAC.
<b>Transformer Output Current</b>	1.4A.
<b>Fuse</b>	250mA, 5 x 20mm Slow Blow.
<b>Cabinet Material</b>	ABS.
<b>Environment</b>	-20°C ~ 60°C, 10% ~ 90% Relative Humidity.
<b>Dimensions</b>	W323 x H293 x D87mm.
<b>Max Weight incl 12V7.5A Batt</b>	3.9Kg.
<b>Mounting Height</b>	2m or lower
<b>Mounting Fixings</b> (not included)	Solid mount to wall with appropriate fixings.

### Mounting Location

This equipment is not suitable for use in locations where children are likely to be present.

Mount in a secure location, ideally out of sight of visitors & intruders.

This product is IPX0 & therefore is suitable for indoor applications only.

Make sure cabinet vents are clear of any immediate or potential obstructions, including linen & insulating material.

Do not mount in ceiling cavities or any area that is likely to exceed 50°C.

### Strain Relief Mechanism & 230VAC Isolation

- This cabinet includes a strain relief mechanism which must be used for both fixed & portable applications
- First remove mechanism by breaking the tab shown here
- Once removed, place the strain relief mechanism over the 230V cable & fix using the screws provided as shown
- Make sure the sheath or jacket of the 230V cable extends at least one-half the diameter of the cord or cable past the strain relief mechanism shown here
- Installation of a 230VAC disconnect device or isolator switch near the alarm cabinet is required for safety and servicing purposes.

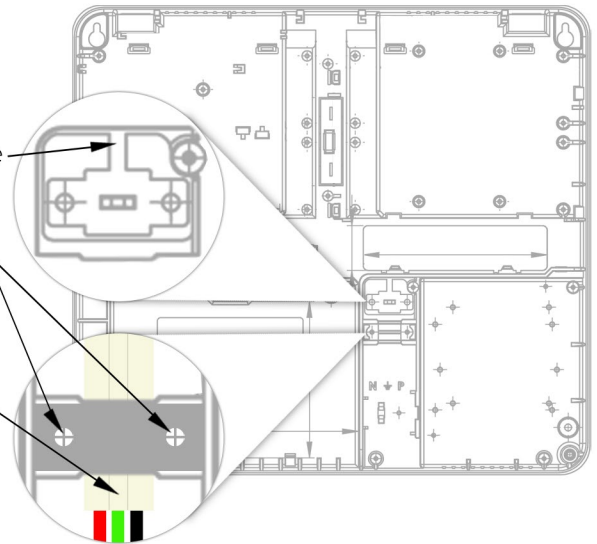

### Securing The Cabinet & Back Up Battery

- All SLA (sealed lead acid) batteries that are mounted in this cabinet must be secured using the 2 x cable tie locations provided

### Cable Tie Locations

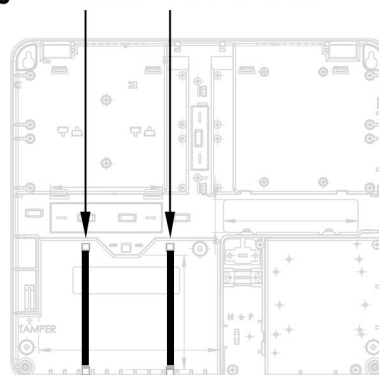

### 5 x Cabinet Fixing Locations

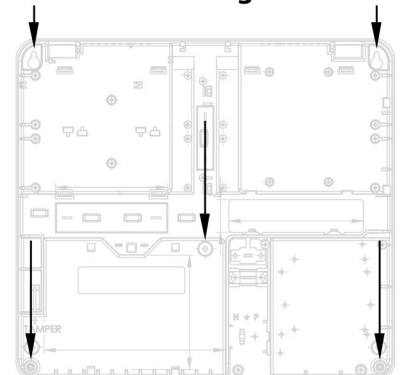

EliteControl & EliteCloud products are proudly manufactured by

