

Specifications

Power Supply	12VDC 150mA (from ESL-2)
Hardware Connection	Plugs into ESL-2
Internet Connection	Ethernet
App Support	EliteCloud
Phone Support	iOS 14 + OR Android 10 +
Dashboard Support	www.elitecloud.co.nz
ESL-2 IoT Updates	Over the Air
ESL-2 Programming	Over the Air
Security Encryption	2048 bits RSA SSL-TLS
Status	LED Indication
Warranty	5 Years

Hardware Connection

- ESL-2 must be powered down before proceeding.
- Plug the 'ESL-2 IoT' directly into the 'ESL-2' control panel (no bus cabling or serial loom required).
- Supply an internet connection to the 'ESL-2 IoT' with an Ethernet cable as shown below:

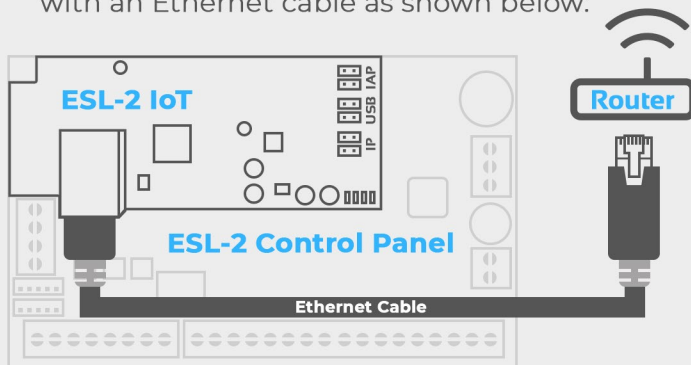

- It is recommended to use the plastic supports provided to help secure the 'ESL-2 IoT' module to the 'ESL-2' control panel.



Requirements:

Hardware

'ESL-2' Control Panel & 'ESL-2 IoT' with internet connection. 'ESL-2 IoT' must be firmware version 4.0.5 or above.

Smartphone

Apple iOS 14 & Above



Android 10 & Above



Account

Users must have an active EliteCloud account. Visit www.elitecloud.co.nz



Status LEDS & Troubleshooting

LED 4 should be fast flashing once network is established & ready for use with app &/or monitoring communication.

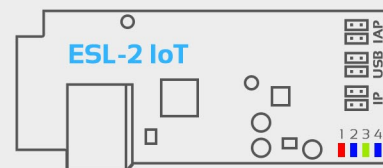

- LED 1 + LED 4 Solid** = No network detected.
- LED 2** = Not utilised on this model.
- LED 3** = Reporting to monitoring or app.
- LED 4 Flashing** = Network detected/ready.
- LED 1 + LED 4 Flashing then Displaying Solid Red** = Module is trying to connect to server.

Programming/Communication Path - **IMPORTANT:** Only 1 path can be used at a time

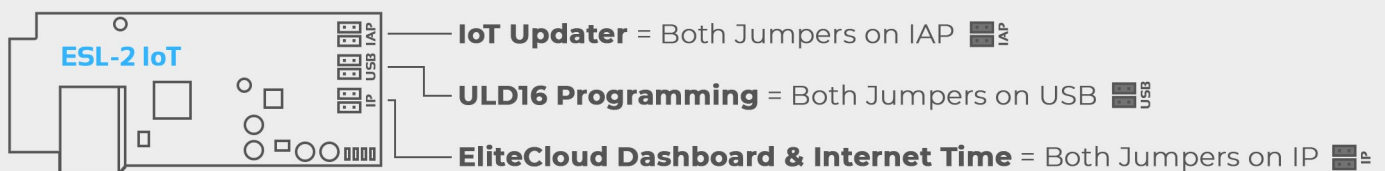

- Refer to 'IoT Updater', 'ULD16 Programming' or 'EliteCloud Dashboard' manuals for more information.

App & Site Setup

- * It is recommended to configure & test each site on your own smart device before handing ownership to the site owner. See steps below for 'Adding Users' & 'Transferring Ownership'.



Download the EliteCloud App

Search EliteCloud on your smart device store, **OR** scan the QR code below:

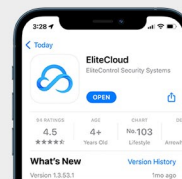

Sign Up, Sign In & Select a Plan

Open the EliteCloud app, press 'Sign Up' & follow the prompts. This process will ask you to register, verify your email, 'Sign In' & select a plan.

If you already have an EliteCloud account, simply open the app, 'Sign In' & move on to the next step.

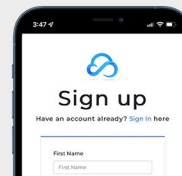

Adding a Site - *Each Site can only be added/owned by 1 User. If required, see below for 'Resetting Ownership'*

After pressing 'Add Site' & accepting the T & C, a QR scanner will appear. Use this to scan the QR code found on your 'ESL-2 IoT' network module. Site ID (MAC & Serial) can also be manually added using the 'Enter manually' button.

Scan this QR code for a step by step video on how to add a site.



Adding & Inviting Users - *All users must have their own EliteCloud account. See step 2*

Go to the 'Users' list found in the main app menu, then press the 'Invite User' icon. Next you can scan the new users 'Account QR Code' found in their 'User Settings' or manually enter their EliteCloud registered email address.

Scan this QR code for a step by step video on how to invite & manage users.



Accepting Invitations & Transferring Ownership

New users must accept any site invitations from within the 'Envelope' icon found at the top left of the sites screen. Once accepted the 'Owner' of the site can transfer ownership from within the 'Users' list found in the main menu.

Scan this QR code for a step by step video on accepting site invitations



Resetting Ownership - *Requires internet*

Shorting the 'Default' pins for more than 15 seconds will remove the module from the server & clear all users. Once LED's 1 - 4 are all solid the module is reset. Module must be V4.0.5 or above

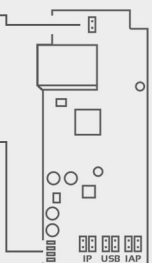

EliteCloud Tutorials

Scan the QR code below to view our EliteCloud & EliteControl tutorial videos.



www.elitecloud.co.nz

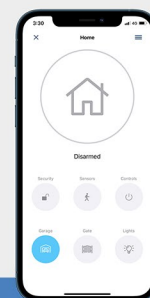

Important

- * Due to the nature of technology development, EliteCloud may not be compatible with all devices
- * It is essential to make sure that all push notification types are being received on your smart device before the system is ready for use. These include: Armed, Stay Armed & 24Hr input alarms, Tamper activations & Arm/Disarm Alerts